

9-19-2011

COLLABORATIVE RESEARCH: Microparticle/ tephra analysis of the WAIS Divide ice core

Karl J. Kreutz

Principal Investigator; University of Maine, Orono, karl.kreutz@maine.edu

Andrei V. Kurbatov

Co-Principal Investigator; University of Maine, Orono, akurbatov@maine.edu

Mark Wells

Co-Principal Investigator; University of Maine, Orono, mlwells@maine.edu

Paul Andrew Mayewski

Co-Principal Investigator; University of Maine, Orono, paul.mayewski@maine.edu

Follow this and additional works at: https://digitalcommons.library.umaine.edu/orsp_reports

 Part of the [Climate Commons](#), [Environmental Studies Commons](#), and the [Glaciology Commons](#)

Recommended Citation

Kreutz, Karl J.; Kurbatov, Andrei V.; Wells, Mark; and Mayewski, Paul Andrew, "COLLABORATIVE RESEARCH: Microparticle/
tephra analysis of the WAIS Divide ice core" (2011). *University of Maine Office of Research and Sponsored Programs: Grant Reports*. 293.
https://digitalcommons.library.umaine.edu/orsp_reports/293

This Open-Access Report is brought to you for free and open access by DigitalCommons@UMaine. It has been accepted for inclusion in University of Maine Office of Research and Sponsored Programs: Grant Reports by an authorized administrator of DigitalCommons@UMaine. For more information, please contact um.library.technical.services@maine.edu.

Final Report for Period: 07/2010 - 06/2011

Submitted on: 09/19/2011

Principal Investigator: Kreutz, Karl J.

Award ID: 0636740

Organization: University of Maine

Submitted By:

Kreutz, Karl - Principal Investigator

Title:

COLLABORATIVE RESEARCH: Microparticle/tephra analysis of the WAIS Divide ice core

Project Participants

Senior Personnel

Name: Kreutz, Karl

Worked for more than 160 Hours: Yes

Contribution to Project:

Name: Mayewski, Paul

Worked for more than 160 Hours: Yes

Contribution to Project:

Name: Wells, Mark

Worked for more than 160 Hours: Yes

Contribution to Project:

Name: Kurbatov, Andrei

Worked for more than 160 Hours: Yes

Contribution to Project:

Post-doc

Name: Osterberg, Erich

Worked for more than 160 Hours: No

Contribution to Project:

Erich has assisted in the design and manufacture of the nickel ice core melt head.

Graduate Student

Name: Koffman, Bess

Worked for more than 160 Hours: Yes

Contribution to Project:

Bess is the project RA, and is working on her MS degree in the Department of Earth Sciences.

Name: Breton, Daniel

Worked for more than 160 Hours: Yes

Contribution to Project:

Dan has led the fabrication of the new software/hardware for the ice core melter system.

Name: Winski, Dominic

Worked for more than 160 Hours: Yes

Contribution to Project:

Dom participated in the 2010/11 WAIS Divide field season, and also assisted in melting our portion of the WAIS Divide core.

Undergraduate Student

Name: Harrington, RObert

Worked for more than 160 Hours: No

Contribution to Project:

Assisted with sample preparation and general laboratory work

Name: Gilman, Brittany

Worked for more than 160 Hours: Yes

Contribution to Project:

Assisted with sample preparation and general laboratory work

Name: Butcher, Kaitlyn

Worked for more than 160 Hours: Yes

Contribution to Project:

Assisted with sample preparation and general laboratory work

Name: Griffin, Shelly

Worked for more than 160 Hours: No

Contribution to Project:

Assisted with sample preparation and general laboratory work

Name: Kane, Eliza

Worked for more than 160 Hours: Yes

Contribution to Project:

Eliza is assisting Bess Koffman and Dan Breton this summer with the ice core melting.

Technician, Programmer

Name: Handley, Michael

Worked for more than 160 Hours: Yes

Contribution to Project:

Mike is the ICP-MS manager, and assists in the design, manufacture, and operation of the melting system.

Other Participant**Research Experience for Undergraduates****Organizational Partners****New Mexico Institute of Mining and Technology**

Dr. Nelia Dunbar is a collaborator on this project, responsible for tephra analysis and interpretation.

Alfred Wegener Institute for Polar**Columbia University Lamont Doherty Earth Observatory****University of Florence**

Bess Koffman visited the University of Florence in Sept. 2009, and worked with researchers there to perform PIXE-PIGE analysis of WAIS Divide snowpit samples.

Cornell University

Other Collaborators or Contacts

We are collaborating with Dr. Urs Ruth and Dr. Anna Wegner from the Alfred Wegener Institute in Germany, on the continuous laser-based particle system. Dr. Ruth has helped us obtain the instrument, and will visited UMaine in March 2009 to assist in calibration.

Drs. Michael Kaplan, Steve Goldstein, and Geisela Wincker at Lamont are collaborating with us on the measurement of Sr and Nd isotopes in WAIS Divide snow and ice for dust source determination.

Dr. Natalie Mahowald at Cornell is collaborating with us on dust modeling results.

Activities and Findings

Research and Education Activities: (See PDF version submitted by PI at the end of the report)

Findings: (See PDF version submitted by PI at the end of the report)

Training and Development:

The following graduate and undergraduate students were trained during the duration of the project:

Bess Koffman (UMaine Earth Sciences PhD student): Bess has been supported full time by the project for the duration of the award. In that time, she has had the opportunity to participate in two WAIS Divide field seasons, has been the primary student conducting laboratory analysis of WAIS Divide ice core and snow pit samples, has done a large amount of education and outreach work, and will likely take the lead on the majority of UMaine WAIS Divide-related publications. In short, the UMaine WAIS Divide grant has given Bess the start of her scientific and academic career. Beyond field and laboratory skills, the project supported Bess' participation in and presentations at several regional, national, and international meetings:

AGU Fall Meeting, San Francisco, CA, Dec. 2011 (upcoming)

WAIS Divide Science Meeting, La Jolla, CA, Oct. 2011 (upcoming)

XVIII INQUA Congress, Bern, Switzerland, July 2011

WAIS Divide Science Meeting, La Jolla, CA, Oct. 2010

DUSTSPEC: Dust Records for a Changing World workshop, Palisades, NY, May 2010

WAIS Divide Science Meeting, La Jolla, CA, Oct. 2009

WAIS Divide Science Meeting, Denver, CO, Oct. 2008

Goldschmidt2008 Geochemistry Conference, Vancouver, BC, Canada, July 2008

WAIS Divide Science Meeting, Kings Beach, CA, Oct. 2007

Bess was recently awarded a travel grant to prepare an OPP postdoctoral fellowship proposal, and is planning to propose further ice core-related dust work either at Cornell or Lamont.

Daniel Breton (UMaine Physics PhD student): Dan was supported by the grant to help develop and build the UMaine continuous melter system that was used to process and analyze the WAIS Divide ice core. His primary advisor was Dr. Gordon Hamilton. As part of his work, he performed a continuous density analysis of the upper portion of the WAIS Divide ice core, producing a unique dataset that was a critical part of his dissertation. The WAIS Divide grant supported his participation in the 2010 WAIS Divide science meeting.

Dominic Winski (UMaine Climate Change Institute MS student): Dom served as one of the

WAIS Divide SCO core handlers during the 2010/11 field season. His MS thesis dealt with glacier energy balance modeling in the Central Alaska Range, however the training and development he received at WAIS Divide and at the 2010 science meeting were invaluable. Eliza Kane (UMaine undergraduate in Earth Sciences and Anthropology, Honors); Eliza worked in the ice core melting lab May-Dec 2010 and was an integral part of our success in melting and analyzing 577 m of ice from the WAIS Divide ice core. Eliza will likely make use of WAIS Divide samples for her senior Capstone project through the Earth Sciences department.

Paul Robinson (Orono High School student and currently freshman at King's College in Nova Scotia); Paul worked two summers (2010 and 2011) through the Orono High School - UMaine Research Experience to develop a new SEM-EDS method to study atmospheric dust in ice cores; funded by NSF EPSCoR grant.

Shelly Griffin (UMaine undergrad in Physical Oceanography with minor in Earth Sciences; currently a Masters student at Iowa State University in isotope geochemistry/paleoclimate); Shelly worked on microparticle analysis in snow samples from West Antarctica and helped develop the ice core melter system.

Brittany Gilman (UMaine undergraduate Earth Science major); Brittany worked in the lab preparing sample vials and equipment.

Robert Harrington (UMaine undergraduate Earth Science major); Robert worked in the lab preparing sample vials and equipment.

Kaitlyn Butcher (UMaine undergraduate Earth Science major); Kaitlyn worked in the lab preparing sample vials and equipment.

Michael Handley (UMaine ICPMS Facility Manager); Mike trained all students who performed trace element analysis as part of this project; he was also instrumental in the development of the UMaine continuous melter system.

Doug Introne (UMaine Stable Isotope Laboratory Manager); Doug trained all students who performed stable isotope analysis (in snowpit samples) as part of this project.

Sharon Sneed (UMaine Ion Chromatography Laboratory Manager); Sharon trained all students who performed major ion analysis (in snowpit samples) as part of this project.

Outreach Activities:

A summary of our notable project outreach talks is as follows (augmenting those already noted in annual reports):

- 2011, Koffman, Guest speaker, Encore Leadership Corps, a statewide adult volunteer program administered by the UMaine Center on Aging
- 2011, Kreutz and Koffman, Asa Adams Elementary School field trip to the Climate Change Institute
- 2011, Koffman, Guest Speaker, "STORMS: Students and Teachers Observing and Recording Meteorological Systems" program through The Island Institute
- 2011, Koffman, Guest Speaker, Climate Change Science Day at the Climate Change Institute (presentations to ~100 students from high schools throughout Maine)
- 2011, Koffman, Guest Scientist, Expanding Your Horizons, part of the National Girls Collaborative Project aimed at advancing the agenda in gender equity for STEM
- 2010, Koffman, Guest speaker, Sunbury Village retirement center, Bangor, Maine
- 2010, Koffman, Invited Speaker, Coastal Studies for Girls, a high-school semester program focused on science and leadership
- 2010, Koffman, Guest lecturer, Orono High School lunch seminar series
- 2010, Koffman, Guest scientist, Expanding Your Horizons, part of the National Girls

Collaborative Project aimed at advancing the agenda in gender equity for STEM
 2009, Kreutz, GE Conversations from Antarctica presentation, ? West Antarctic Ice Sheet
 Divide Ice Core Project, Schenectady, NY, April 25-26
 2008, Koffman, Guest lecturer and panel organizer for 120-student audience Upward
 Bound, a science program for underprivileged Maine youth
 2008, Koffman, Guest lecturer, Stillwater Montessori School
 2008, Koffman, Guest lecturer, Morison Memorial Elementary School

A summary of our notable project media coverage and products is as follows (augmenting those already noted in annual reports):

2011, Kreutz, commentary for Nature on relationships between U.S. and Canadian ice core communities
 2011, Koffman, Invited to write guest essay, ?Ice cores: archives of past climate? on ?Punctuated Equilibrium? blog hosted by The Guardian, 10 June 2011
 2011, Koffman, Featured in article, ?How do ice cores allow researchers to see climate change??on ?Punctuated Equilibrium? blog hosted by The Guardian, 12 May 2011
 2011, Koffman and Kreutz, Outreach video featured on the National Science Foundation?s Science 360 News Service: Breaking science that shapes your world website, 11 May 2011
 2011, Koffman, Coverage of newly designed ice core melter system in UMaine Today magazine blurb, ?Ice Time,? Spring 2011 issue
 2011, Koffman and Kreutz, Outreach video featured on UMaine?s YouTube channel and on WAIS Divide ice core project website
 2010, Koffman, Featured in Antarctic Sun magazine article, ?On the line: researchers spend summer in deep-freeze to slice and dice WAIS Divide ice core,? August 2010
 2010, Koffman, Featured in Bangor Daily News article, ?Melting ice at core of climate study,? July 2010
 2010, Koffman, Coverage of research on 3 local TV stations: WLBZ2 (NBC), WABI TV5 (CBS), and WFVX 7 (ABC and FOX), July 2010
 2008, Koffman, Co-wrote ?Climate change side effects? op-ed piece in the Bangor Daily News with father Ted Koffman, April 2008

Journal Publications

Ahn, J., Brook, E., Schmitner, A., Kreutz, K., and Mayewski, P., "Abrupt change in atmospheric CO₂ during the last ice age", Nature, p. , vol. , (2010). in preparation,

Breton, D., Koffman, B., Kreutz, K., Kurbatov, A., Mayewski, P., Handley, M., "On a hybrid ice core melting system for geochemical and microparticle analysis", Environmental Science and Technology, p. , vol. , (2011). in preparation,

Koffman, B., Kreutz, K., Marino, F., Kurbatov, A., Mayewski, P., Handley, M., Wells, M., "Recent dust provenance in West Antarctica inferred from PIXE-PIGE analysis", Geophysical Research Letters, p. , vol. , (2011). in preparation,

Koffman, B., Kreutz, K., Kurbatov, A., Mayewski, P., Handley, M., Wells, M., "Southern Hemisphere climate controls on dust variability", Journal of Geophysical Research, p. , vol. , (2011). in preparation,

Koffman, B., Dunbar, N., Kurbatov, A., Kreutz, K., "New insights into atmospheric transport using an ultra-high-resolution ice core record of volcanic aerosol deposition", Journal of Geophysical Research, p. , vol. , (2011). in preparation,

Daniel J. Breton, Ghislain Picard, Gordon S. Hamilton, "A Unified model of firn optics: Optical scanning in air-ice mixtures from snow to solid ice", Journal of Glaciology, p. , vol. , (2011). in preparation,

Daniel J. Breton, and Gordon S. Hamilton, "Photonic Analysis of Density Inversion in a WAIS Divide Ice Core", Journal of Glaciology, p. , vol. , (2011). in preparation,

Books or Other One-time Publications

Koffman, B., "Atmospheric dust deposition in West Antarctica: Iron biogeochemistry, dust provenance, and climatic significance", (2012). Thesis, in preparation
Bibliography: University of Maine PhD dissertation

Daniel J. Breton, "Photonic non-destructive measurement methods for investigating the evolution of polar firn and ice", (2011). Thesis, Published
Bibliography: Ph.D. dissertation. United States -- Maine: The University of Maine

Web/Internet Site

URL(s):

http://gcmd.nasa.gov/getdif.htm?kreutz_0636740

Description:

Our current data is stored on the participant section of the WAIS Divide website, where access is restricted to WAIS Divide PIs and associated personnel. We have also established a project data website on the Global Change Master Directory, and have supplied project data to Rob Bauer (NSIDC) to be linked to the GCMD website for public access.

Other Specific Products

Product Type:

Data or databases

Product Description:

We have placed our snowpit and ice core data collected thus far on the WAIS Divide participant website.

As more snowpit and ice core data become available, we will continue to place it there.

Sharing Information:

For the moment, only WAIS Divide PIs and associate personnel have access to the internal WAIS Divide website, so data dissemination is limited through this portal. We have also emailed requested datasets to individuals within the WAIS Divide community.

Product Type:

Data or databases

Product Description:

We have established a website on the Global Change Master Directory to archive and distribute all data associated with this project. Thus far, snowpit and ice core data provided for the WAIS Divide participant site have also been provided for the GCMD site, and we will populate both websites with any additional data as it becomes available.

Sharing Information:

We will list this website (GCMD) in all publications and highlight it during all presentations. In

addition, the data archive website will be promoted on the UMaine Climate Change Institute and Department of Earth Science websites. We will also cross-link with the Ice Core Gateway/NSIDC ice core data archive websites.

Contributions

Contributions within Discipline:

The modifications and improvements made to our melter system as part of our WAIS Divide project are a contribution to other national and international collaborators who use similar systems. The data enabled by this system (namely continuous particle size data) are of value to the WAIS Divide community in the form of a contribution to the core dating effort, and of course to the interpretation of atmospheric dynamics, climate, ocean biogeochemistry, and carbon cycle dynamics.

Contributions to Other Disciplines:

The data enabled by our modified melter system (namely the ability to analyze several different chemical fractions from each sample, and co-register it with other related data) are of interest to a wide range of communities, including glaciology, atmospheric chemistry and dynamics, and oceanography. Our snowpit results, particularly the relationship between total and chemically labile Fe concentration, have already been widely discussed in the chemical oceanographic community.

Contributions to Human Resource Development:

Human resource development was primarily focused on graduate and undergraduate student education in Earth Sciences, Marine Sciences, and Engineering; UMaine technical staff also benefited from involvement in the project.

Contributions to Resources for Research and Education:

Contributions to resources were primarily related to the improved melter system, which will be used on several additional projects beyond the WAIS Divide effort (e.g., South Pole core).

Contributions Beyond Science and Engineering:

Our contributions beyond science and engineering have been in the education realm, (hopefully) inspiring new students to enter Earth Sciences, and educating the public on climate change issues.

Conference Proceedings

Koffman, BG;Kreutz, K;Handley, M;Wells, M;Kurbatov, A;Mayewski, P, A snowpit record of atmospheric Fe deposition in West Antarctica at the WAIS Divide site, "JUL, 2008", GEOCHIMICA ET COSMOCHIMICA ACTA, 72 (12): A487-A487 Suppl. 1 JUL 2008

Categories for which nothing is reported:

RESEARCH AND EDUCATION ACTIVITIES

A summary of our research and education activities for the entire length of the grant, including the past year (July 1 2010 to June 30 2011) follows:

1. WAIS Divide field work

UMaine graduate students participated in the 2008/09 (Koffman), 2009/10 (Koffman), and 2010/11 (Winski) WAIS Divide field seasons as SCO core handlers. This provided unique and valuable experiences, and is a major research and education activity for this project. Koffman is planning to continue in academia, seeking a postdoctoral position in ice core science when her UMaine PhD is complete; Winski graduated in August 2011 and is pursuing PhD program options in glaciology. While in the field, Koffman collected large volume snowpit samples for chemical analysis, at UMaine, the University of Florence (Italy), and Lamont. In addition, a former UMaine MS student (Ben Gross, Kreutz advisor) was a IDDO driller at WAIS Divide during the 2009/10 season.

2. WAIS Divide core processing line, and other NICL sampling

UMaine participated in the 2007 (Kurbatov) and 2008 (Koffman) WAIS Divide CPLs. Kreutz also visited NICL in 2009 to sample tephra from the WAIS Divide core for the project. This CPL work, combined with field work, represented a significant personnel commitment to the overall project as well as research and education activities.

3. Snowpit sampling and development of chemical processing techniques

Bess Koffman developed an innovative and detailed processing scheme for large volume snowpit samples, including filtration and various modes of sample leaching and acidification to quantify various chemical fractions (see Findings section). These methods are being used to process samples from the WDC06A core.

4. Development of UMaine discrete hybrid melting system

The University of Maine ice core continuous melting hybrid sampling (CMHS) system, developed as part of this project (Breton et al., 2011)

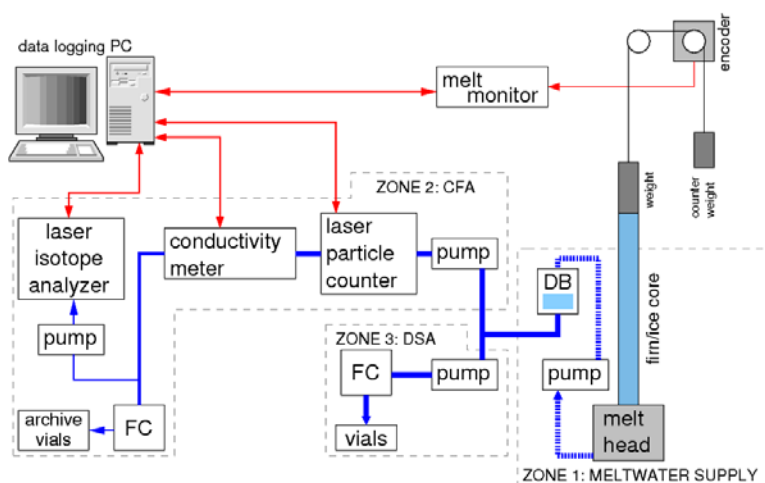

The UMaine ice core continuous melting hybrid sampling system (Breton et al., 2011), including proposed Picarro water isotope analyzer for continuous isotope analysis. (DB = debubbler; FC = fraction collector)

instruments and automates all aspects of the melting process, including: 1) precision (± 0.1 mm) real-time measurement of melt displacement and melt speed; 2) automated operation of inner and outer fraction melt head pumps to minimize both inner fraction contamination, and maximize inner fraction sample recovery; 3) inner and outer fraction line optical sensors to determine air/water fraction, providing operator with diagnostic data on melting process (i.e. flooding of the melt head, no/low flow in outer fraction, etc.); 4) automated de-bubbler level control system utilizing the output from multiple optical level sensors to control pump speeds for maintenance of proper de-bubbler level and prevention of continuous flow analysis (CFA) equipment damage due to bubbles; 5) precision metering of sample volume in the discrete sampling analysis (DSA) section via automated fraction collector control; 6) parcel tracking algorithm to robustly co-register

samples/data from both the DSA and CFA sections of the melter; 7) real-time data collection and storage of all melter system parameters, DSA sample numbers and CFA instrument data streams, including cross-communication of time and depth information from the melter to the CFA data collection programs for precise depth co-registration; and 8) centralized control station on a single PC allowing rapid and precise operator control of the melting system and data recording at one location.

Of all of these significant improvements, the parcel tracking algorithm stands out for its potential value to ice core melting systems being implemented by national and international colleagues (Breton et al., 2011). The algorithm can not only correctly track the transport of a given section of ice core throughout the sample handling system, it also allows for objective quantification of the signal dispersion within the melting system. For analysis of a real core, robust and precise depth co-registration is essential for correct interpretation of the relative phasing of geochemical signals. The figure shows a volcanic eruption recorded within the WAIS Divide WDC06A (West Antarctica) core. Because of the millimeter-scale co-registration, we can say with confidence that the micro-particle transient began and ended before the longer-term effects of volcanic sulfate had any effect on the conductivity at WAIS Divide.

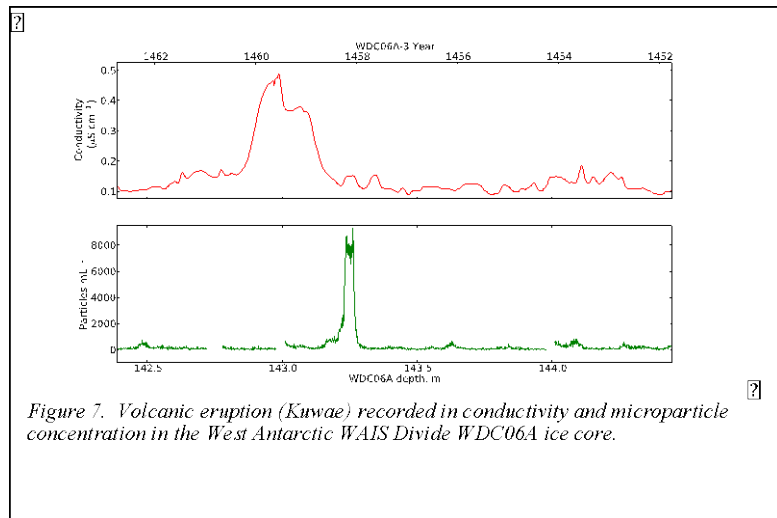
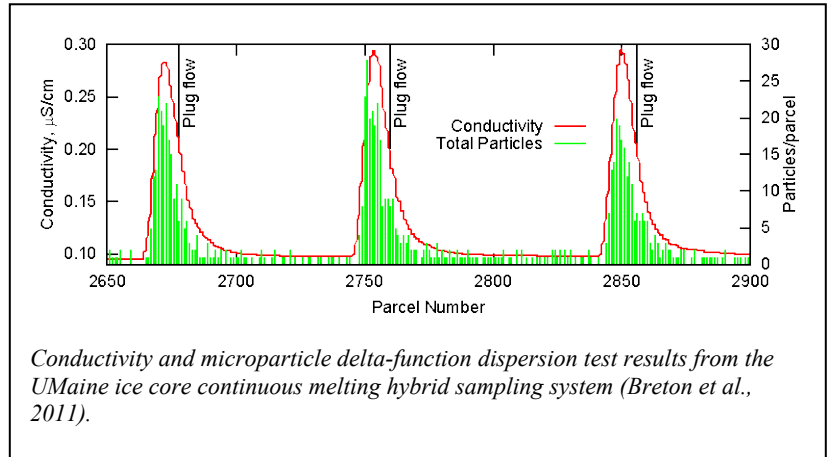

5. Processing of WAIS Divide WDC06A core

Our stick of the WAIS Divide ice core (0-577 meters depth) was analyzed for continuous high resolution density (using the MADGE system, 0-160 meters depth; Breton, 2011), continuous electrical conductivity and microparticle analysis (0-577 meters depth), and trace element analysis at discrete intervals (0-577 meters depth). The processing took place during summer and fall of 2010. Data are archived on the WAIS Divide participants website, and through the Global Change Master Directory/NSIDC. See Findings sections for results.

6. Tephra sampling and analysis

In order to select sampling intervals with tephra layers supplied by major tropical volcanic eruptions in WAIS Divide ice core, we used the ice chemistry data set provided by J. Cole-Dai and the depth/age dataset provided by Joe McConnell and Ken Taylor. Ice from four sampling intervals (Table 1) was collected during a visit to NICL during March 2009.

Depth(m) in WDC05A	Depth (m) in WDC06A	Volcanic eruption
16.4-16.6	16.287- 16.414	Agung (Fig. 1.1).
40.061 - 41.13	40.117-40.993	Mt. Krakatau 1883 and Mt Tarawera, 1886 (Fig. 1.2).
53.598-54.152	53.45-53.88	Coseguina in 1835 (Fig. 1.3).
58.9-59.5	58.71 - 59.25	Tambora in 1815 (Fig. 1.4).
60.84-61.03	60.25- 60.76	Unknown 1809 (Fig. 1.4).

Sample	Top	Bottom	Year Top ¹	Year Bot. ¹	Sampled NICL	Sampled CCI	Possible source
WDC06A-1	16.29	16.41	1965.4	1965.1	4-27-09	6-5-09	Agung
WDC06A-2	40.12	40.99	1888.2	1884.7	4-27-09	6-5-09	Krakatau/Okataina
WDC06A-3	53.45	53.88	1837.8	1835.3	4-30-09	6-5-09	Coseguina
WDC06A-4	58.71	59.25	1818.3	1816.3	5-21-09	6-5-09	Tambora
WDC06A-5	60.25	60.76	1812.7	1810.3	5-21-09	6-5-09	Unknown

Table 1. Depth of possible volcanic layers in the WDC06A core and location of our samples.

7. Participation and presentation of data at professional meetings

To date, our results from the WAIS Divide ice core have been presented at several regional/national/international meetings, including:

AGU Fall Meeting, San Francisco, CA, Dec. 2011 (upcoming)

WAIS Divide Science Meeting, La Jolla, CA, Oct. 2011 (upcoming)

XVIII INQUA Congress, Bern, Switzerland, July 2011

AGU Fall Meeting, San Francisco, CA, Dec. 2010

WAIS Divide Science Meeting, La Jolla, CA, Oct. 2010

DUSTSPEC: Dust Records for a Changing World workshop, Palisades, NY, May 2010

AGU Fall Meeting, San Francisco, CA, Dec. 2009

WAIS Divide Science Meeting, La Jolla, CA, Oct. 2009
WAIS Divide Science Meeting, Denver, CO, Oct. 2008
Goldschmidt2008 Geochemistry Conference, Vancouver, BC, Canada, July 2008
WAIS Divide Science Meeting, Kings Beach, CA, Oct. 2007
UMaine CCI Borns Symposia, 2007-2011
UMaine Earth Science Department Brown Bag seminars, 2007-2011

8. Education activities (incorporation into curriculum)

Data and ideas from this project were used in several UMaine courses taught by the PIs, including ERS200: Earth Systems, ERS201: Global Environmental Change, ERS369: Energy Resources and Climate Change, ERS527: Isotope Geology. In each case, some combination of data, ideas, examples of hypothesis formation and testing, field work context, and general Antarctic science context was used to highlight the importance of WAIS Divide research in the broader global climate change field.

9. Student/professional training and development

These activities are detailed in a following report section.

10. Outreach activities

Our outreach activities associated with this project are detailed in the outreach section.

11. National/international collaborations: We have continued our collaboration with Dr. Urs Ruth and Dr. Anna Wegner from the Alfred Wegener Institute for Polar and Marine Research. Drs. Ruth and Wegener are two of the foremost European scientists working on ice core dust records, and are responsible for most of the high resolution dust records from the EPICA and North GRIP ice cores. They were instrumental in the development and calibration of our WAIS Divide ice core melter system. Through them, we established a new collaboration with Dr. Federico Marino and colleagues at the University of Florence. Dr. Marino is an expert in PIXE-PIGE analysis of ice core dust samples. Bess Koffman spent two weeks in Florence in Sept. 2009, working with Dr. Marino to produce trace element and oxide data from her WAIS Divide snowpit samples. We expect to continue this collaboration and extend the analyses to WAIS Divide core samples taken from our melter system. Finally, we continue to pursue collaboration with colleagues (Mike Kaplan, Steve Goldstein, Gisela Winkler) at Lamont Doherty Earth Observatory on the Sr and Nd isotopic composition of WAIS Divide dust samples. We recently provided the Lamont group with large volume (several liter) WAIS Divide snowpit samples, and Bess Koffman visited Lamont in August/September 2011 to participate in TIMS analysis of the samples.

FINAL REPORT

FINDINGS

1. Snowpit analysis and sample processing experiments

We completed analyses on snowpit samples recovered from the WAIS Divide site in 2005 by Ken Taylor and Mark Twickler, and the snowpit samples collected by Bess Koffman at WAIS Divide during 2008/09. Together, these snowpit samples are critical for two reasons: 1) They are the only samples that bring the WAIS Divide deep core to the 2005 surface before it was excavated for drill installation, and 2) the large snow volumes collected (500ml) have allowed us to test various processing and analysis methods, in preparation for ice core processing.

Samples from the snowpit collected during 2008/09 have been analyzed for major ions, stable isotopes, trace elements, and dust concentration/size distribution (Figure 1). As expected, there

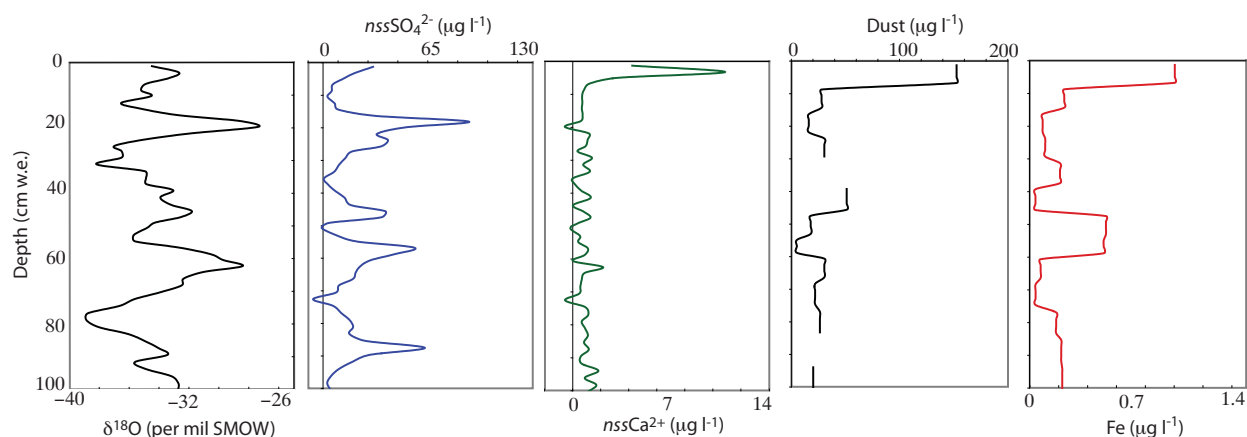

Figure 1. Snowpit isotope, chemistry, and dust concentration data from the WAIS Divide 2008/09 snowpit.

are clear annual signals in $\delta^{18}\text{O}$ and nssSO_4^{2-} , but dust seasonality, as measured in nssCa^{2+} , dust concentration, and Fe concentration, shows no obvious seasonality. There is a large dust peak near the surface of the pit, possibly reflecting a late spring/early summer storm and/or dust event. We are focusing our effort on this event to better understand the relationship between particle size distribution and chemistry. One of the samples sent to Lamont for Sr/Nd isotope analysis contains this layer, and we will attempt to see if there is any appreciable change in dust source between a large dust event and “background” conditions. These snowpit data have been submitted to the WAIS Divide participants-area website, and to GCMD.

We completed experiments with sample acidification strength and time using samples recovered during 2008/09. Figure 2 shows Fe concentration data for a coregistered set of snowpit samples, acidified at 3 different acid strengths: 0.1%, 1%, and 10% HNO_3 . As

expected, higher acid strength results in higher Fe (and all other trace metal) concentrations. However, leach time also clearly plays a major role. Aliquots have been removed at set times during the experiment, which is currently out 6 months.

Figure 1 shows the different concentration growth rates at the different acid strengths, with the high acid concentration showing the clearest asymptotic behavior. Moreover, after 3 months, there is roughly a 3-fold difference in Fe concentration between the different acid strengths. These results clearly show the potential offsets that can occur between data produced with different processing techniques (e.g. continuous melter vs. discrete samples), and therefore begs caution when comparing datasets analyzed by different labs with different techniques. Based on these results, we have decided to use a one month 10% acidification strength on our ice core samples, which we feel represents the optimal combination of time and method compatibility. These data have been submitted data to the WAIS Divide participants-area website and GCMD; Bess Koffman is in the process of publishing results in a peer-reviewed journal and her dissertation.

Selected snowpit samples from the 2008/09 snowpit were analyzed via PIXE-PIGE (e.g. Marino et al., 2008) at the University of Florence in September 2009 by Bess Koffman and Dr. Federica Marino. This technique holds

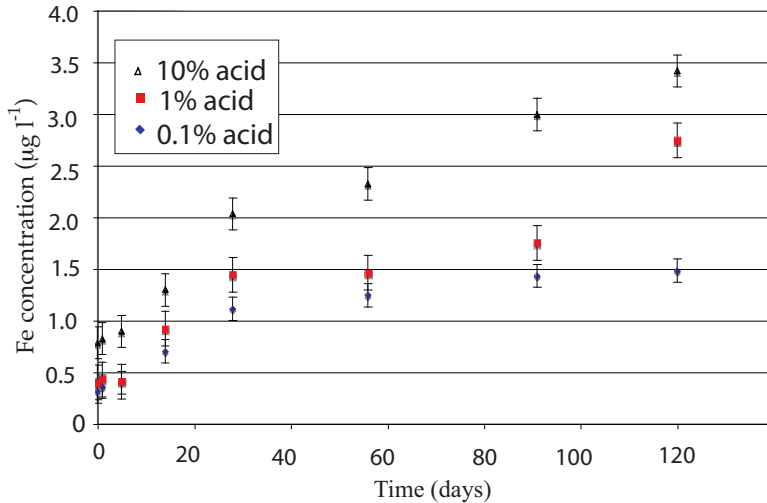

Figure 2. Results of acidification experiment using WAIS Divide snowpit samples collected in 2008/09.

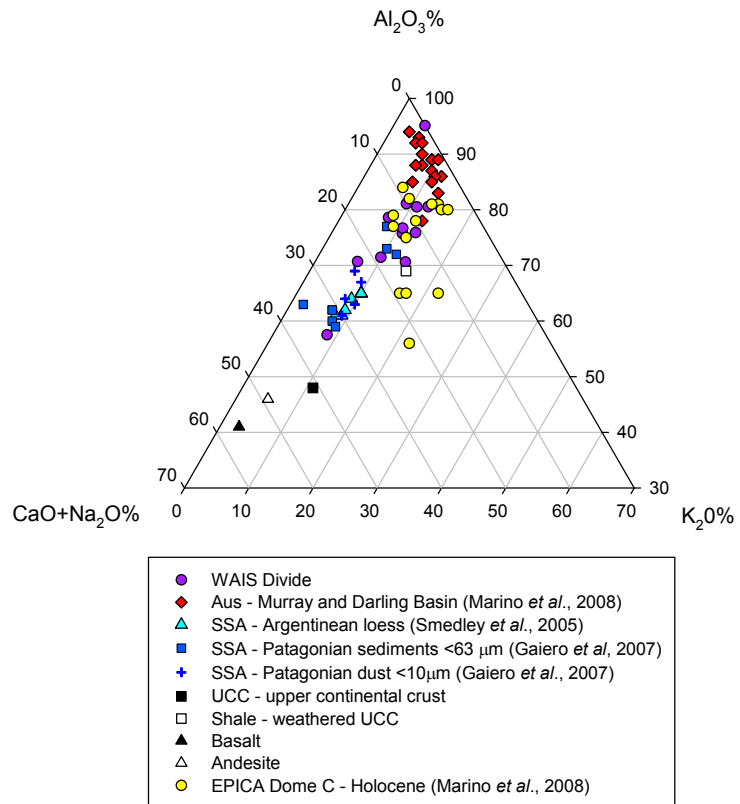

Figure 3. PIXE analysis of WAIS Divide snowpit samples, compared to other East Antarctic data and potential source areas.

promise for accurate geochemical characterization of dust for unique source characteristics. For example, Marino et al. 2009 were able to show using PIXE-PIGE major element data from EPICA Dome C ice core dust samples that the likely source of Dome C during the LGM was South America. This result confirms previous Sr and Nd isotope data from East Antarctica. However, Holocene Dome C dust samples display much greater variability and high Al content, suggesting the Australia is an additional, and significant, source during warm interglacials. Based on modeling data, our hypothesis is that Australia is the primary dust source for West Antarctica, which we seek to test with PIXE-PIGE major element data. Figure 3 is a ternary plot with the Marino et al. 2009 data, South America and Australia source region data, and our WAIS Divide dataset. Our preliminary interpretation is that Australia is indeed a dominant dust source for West Antarctica. However, we also hypothesize that New Zealand may play a role in dust transport to West Antarctica, and plan to further pursue this idea with Lamont using Sr/Nd/Pb isotopes. We are in the process of submitting these snowpit data to the WAIS Divide participants-area website and GCMD. Bess Koffman is in the process of publishing results in a peer-reviewed journal and her dissertation.

2. Ice core melting (density, microparticle, conductivity, and chemical analysis)

We began processing the upper 0-160 meters of the WAIS Divide ice core using the MADGE automated density gauge (Breton, PhD dissertation, 2011). These data represent, to our knowledge, the highest resolution, continuous density data for any deep polar ice core (Figure 4). The MADGE density data were compared with optical scattering measurements and digital photography. Combining the results of both bulk density and optical scattering measurements for the same core reveals that microstructure-dependent densification did occur at this site and is readily detectable by purely photonic methods. This work lays the theoretical and experimental foundations for a novel, non-destructive and field deployable instrument for further study of structure-dependent firn densification. Also, disturbance of the upper 2 meters of snow from arch construction is evident in the data. Dan Breton is in the process of publishing these data; data are available on the WAIS Divide website and through GCMD.

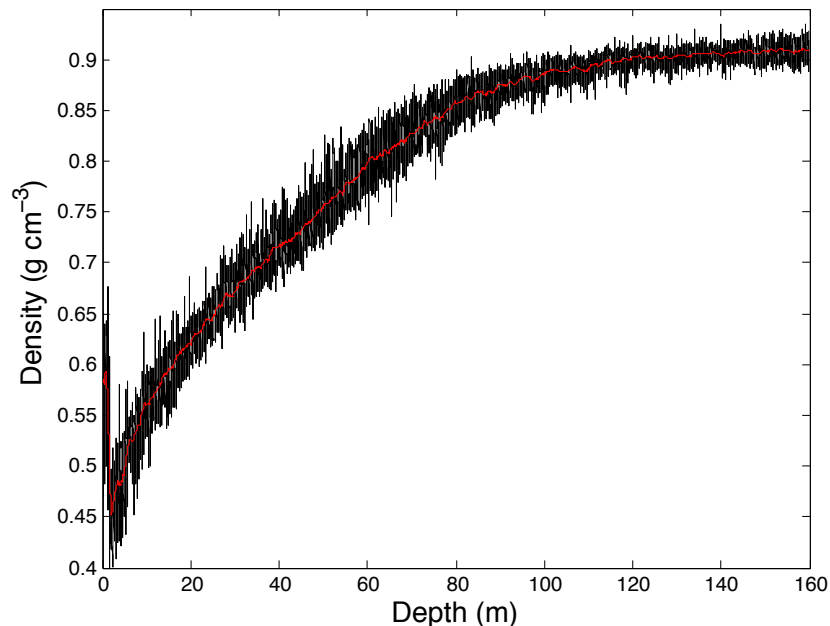

Figure 4. MADGE density data from the WDC06A core (Breton, 2011).

We processed the entire 0-577 meter portion of the WDC06A core using the UMaine continuous melter system, producing microparticle (32 size channels) and conductivity data with mm-scale resolution. We find a clear seasonality in microparticle deposition (Figure 5), however the phasing relative to conductivity and other chemical indicators varies. In general, however, the predominant season of deposition appears to be spring. Our initial hypothesis is that this phasing is related primarily to atmospheric transport, rather than specific source conditions.

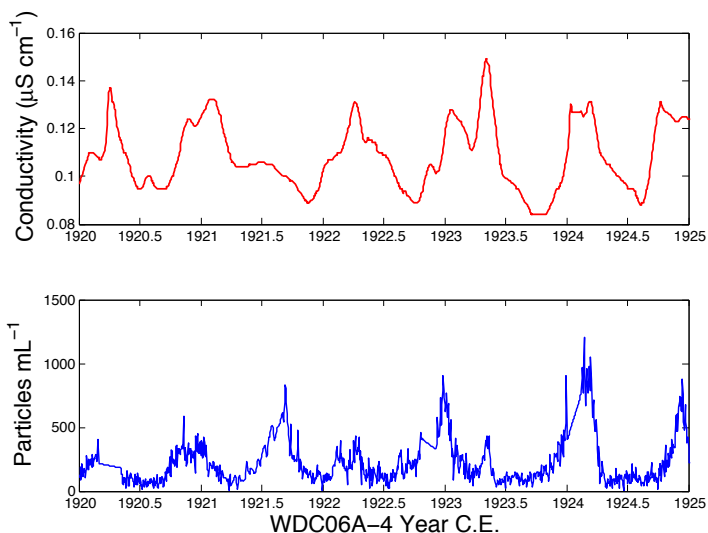

Figure 5. Seasonal microparticle and conductivity signals from the WDC06A core.

The full microparticle record from 0-577 meters depth shows and number of interesting features. First, the raw data (without data from core breaks removed) is viewed (Figure 6), there is a clear distinction between the upper firm section (i.e., drilled without fluid) and the lower ice section (drilled with fluid). Clearly, the ice section appears to contain significantly more microparticles. Our hypothesis is that the drill cable itself was producing material in the borehole, which was then transferred into core breaks (when breaks were made in the borehole, not cuts made with saws on the surface). This finding is consistent with field observations, where black material was seen coming off of the drill cable. We are in the process of obtaining some of this material for chemical and physical analysis, to compare with our microparticle data.

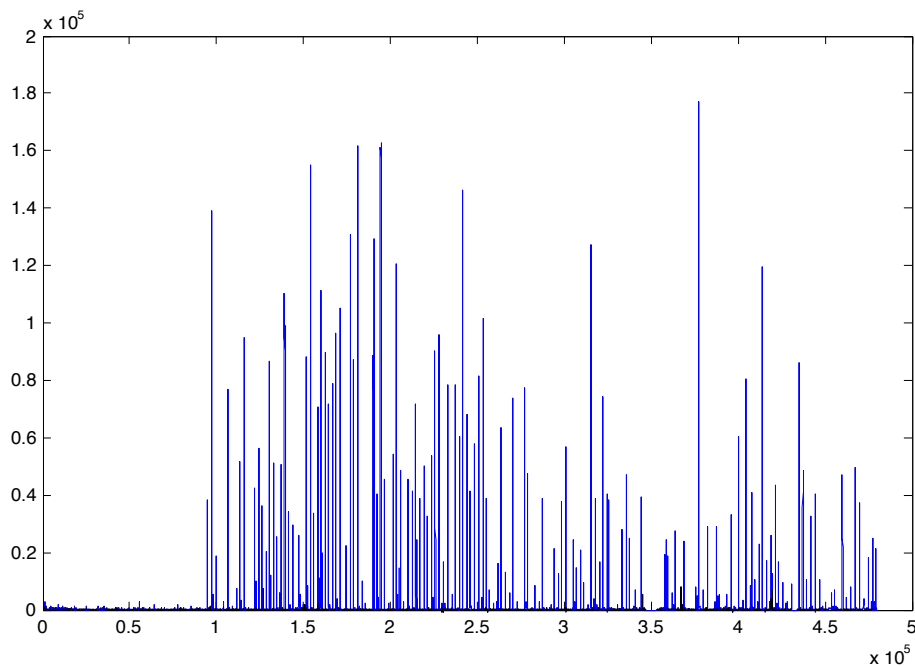

Figure 6. Microparticle concentration (particles/ml) vs. depth (m) in the WDC06A core (raw data). The transition between firm and ice, and dry vs. wet hole is clear at around

The full microparticle record (2400 years) displays a number of interesting features. First, we find that there are relatively low background dust conditions at WAIS Divide for the entire period, with several large deposition events spaced throughout the record (Figure 7). Second, there is a clear increase in dust deposition in the late 20th century (Figure 8), particularly after 1980. We hypothesize that this increase is due in part to anthropogenic activity, either through land use changes and/or the change in southern hemisphere circulation linked to the Southern Annular Mode (SAM). Size distribution data (Figure 9) suggests that changes in dust emission were responsible, as there is no obvious change in the coarse particle percentage during the same time period. However, the link to the SAM cannot be ruled out, and in fact is potentially strengthened when the full microparticle dataset is analyzed for its frequency components (Figure 10). Our initial findings indicate significant periodicity in the interannual to multidecadal bands, particularly from 1350 to 1600. We hypothesize a link to the SAM, similar to that observed in the Law Dome ice core dust record. We are just beginning these analyses, but expect that the high resolution nature of both the WAIS Divide and Law Dome dust records will yield new and interesting findings related to southern hemisphere climate dynamics. Microparticle data from the core have been submitted to the WAIS Divide website and the GCMD.

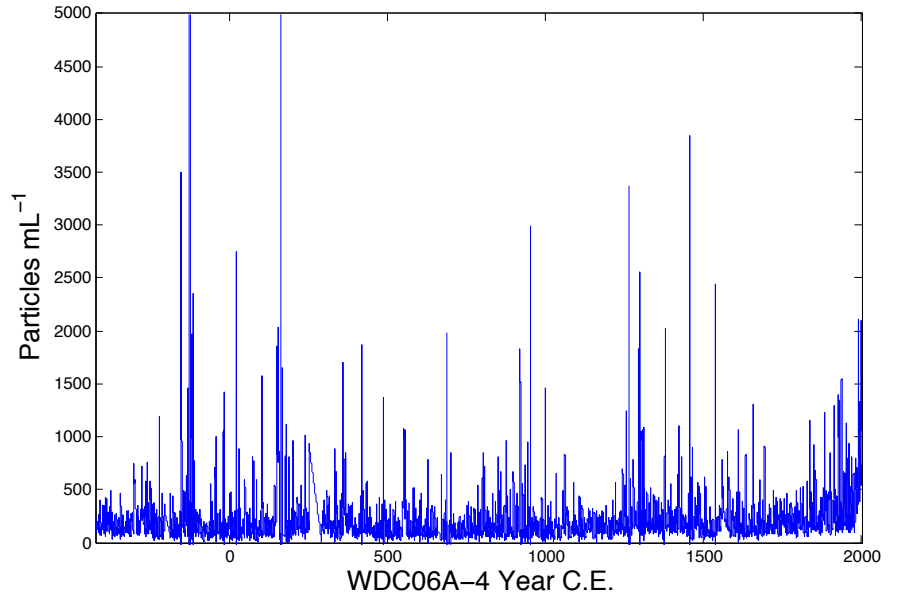

Figure 7. Microparticle data, low pass filtered, from the WDC06A core. Data from core breaks has been removed.

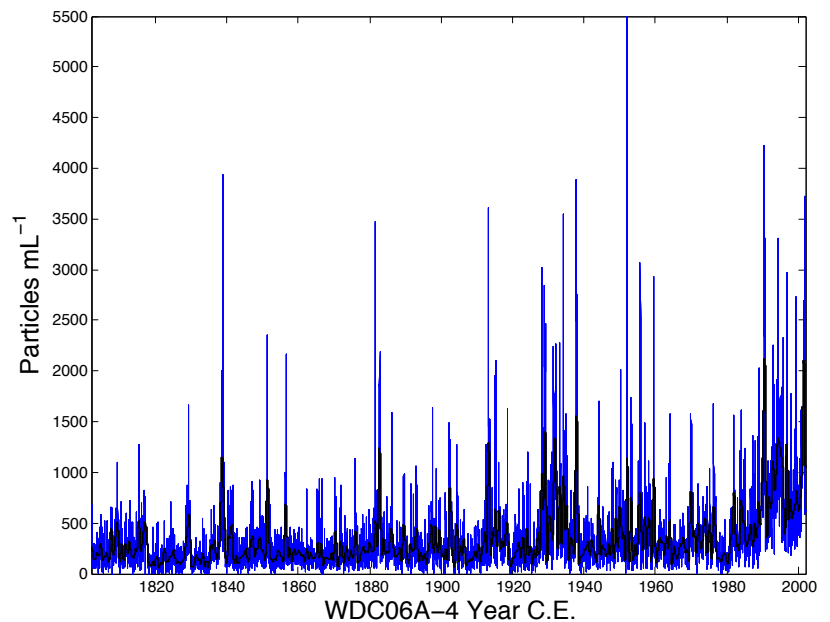

Figure 8. Annual microparticle data from the WDC06A core, 1800-2000 AD, with a 10-year running mean applied, showing a clear increase after 1980.

3. Tephra analysis of potential tropical eruptions

In order to select sampling intervals with tephra layers supplied by major tropical volcanic eruptions in WAIS Divide ice core, we used the ice chemistry data set provided by J. Cole-Dai and the depth/age dataset provided by Joe McConnell and Ken Taylor. Ice from four sampling intervals was collected during a visit to NICL during March 2009. Samples were returned to UMaine, where they were processed using established tephra procedures. After melted samples were passed through a filter, half of the membrane was sent to collaborator Dr. Nelia Dunbar for microprobe analysis. In general, Nelia found many particles, but very little volcanic glass. Interestingly, there was a high percentage of carbonate particles in the WDC06A core samples. There were a few glass shards on each filter (the most on filter WDCA03), but nothing that looked like a real population. Microprobe data from the samples is given in Table 1. We are working on determining potential sources. One possibility is that tropical tephra never made it to the WAIS Divide site, or is smaller than 10 microns, which is the limitation of our method. Tephra data have been submitted to the WAIS Divide website and GCMD.

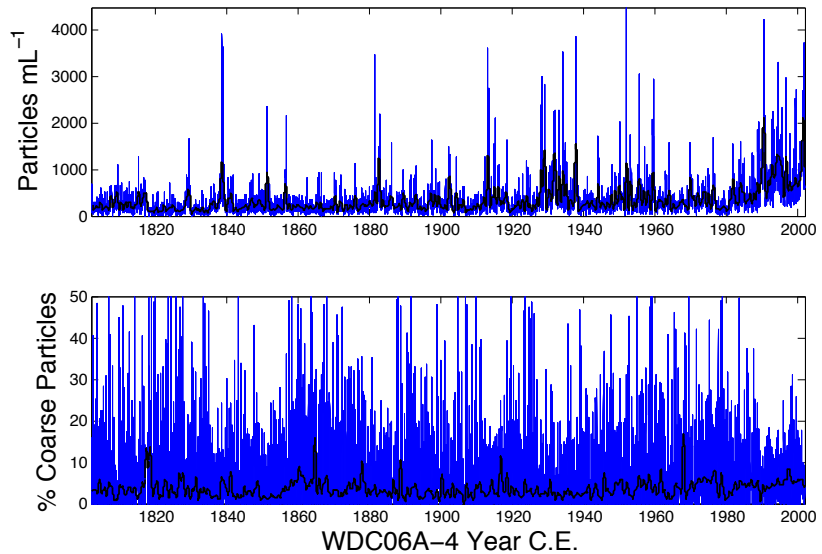

Figure 9. Microparticle concentration and coarse particle percentage from the upper portion of the WDC06A core.

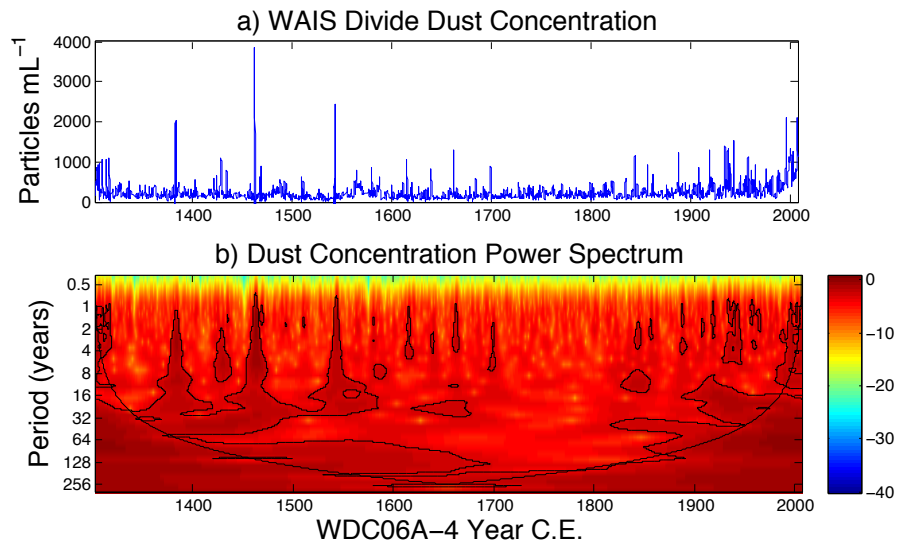

Figure 10. Wavelet analysis of the WDC06A microparticle record, highlighting interannual to multidecadal variability from 1350 to 1600 AD.

Sampling WDC06A ice core for tephra particles did not reveal tephra from known large tropical volcanic eruptions. This data set will contribute to the development of the regional

tephrochronological framework. Over the past few decades, the tephrochronological framework of the Antarctic continent has been maturing through a range of studies on tephra in ice cores and blue ice areas, as well as on potential source volcanoes within the Antarctic continent. Geochemical fingerprinting of tephra in WDC06A ice core will facilitate cross-correlation of time-lines among different environmental records of ice, lakes, and marine cores, thus establishing a major framework for global paleoclimate reconstructions required for understanding past, present, and future climate. As of yet, no single compilation of analytically robust, easily accessible tephra geochemistry and geochronology exists. Both, Kurbatov and Dunbar submitted proposals to NSF - OPP that request additional resources for the development of the regional Antarctic tephra database (PI Kurbatov, Collaborative research: Developing an Antarctic tephra database for interdisciplinary paleoclimate research (AntT)).

A significant aspect of the broader impacts for this project involves fostering and promoting international communication and cooperation in the tephra-in-ice community. At present, a number of researchers from different countries are involved in rigorous geochemical investigations on tephra in ice cores from around the Antarctic continent. This project has the potential to further international cooperation by making a wide range of tephra data available to researchers from the U.S., Chile, Europe and New Zealand, facilitating exchange of information. Kurbatov and Dunbar are among organizers of session: “Improving identification of volcanic products in ice cores using the latest developments in volcanology,” in AGU Fall 2011 meeting.

Sample ID	P ₂ O ₅	SiO ₂	SO ₂	TiO ₂	Al ₂ O ₃	MgO	CaO	MnO	FeO	Na ₂ O	K ₂ O	F
WDC06A-1-03	0.07	73.90	0.12	0.04	15.47	1.43	3.63	0.00	0.53	0.47	4.28	0.04
WDC06A-1-07	0.50	51.76	0.19	2.86	14.34	4.61	8.61	0.13	12.11	3.95	0.80	0.14
WDC06A-1-08	0.05	77.19	0.80	0.17	11.78	0.07	0.30	0.02	1.77	1.32	6.52	0.00
WDC06A2-01	0.02	77.50	0.04	0.10	12.53	0.04	0.75	0.03	0.76	3.22	5.02	0.00
WDC06A2-02	0.85	45.82	0.12	4.43	13.73	5.83	9.28	0.22	11.46	4.91	3.18	0.17
WDC06A2-06	1.59	49.06	0.16	2.63	18.81	3.16	9.26	0.18	6.61	5.40	2.85	0.29
WDC06A3-026	1.20	44.68	0.07	4.02	16.92	4.72	12.43	0.20	10.45	3.90	1.25	0.15
WDC06A3-01	1.36	47.49	0.65	2.92	16.85	3.95	9.18	0.20	7.66	7.25	2.41	0.07
WDC06A3-014	1.25	48.31	0.17	2.91	16.84	4.47	6.04	0.23	9.03	6.89	3.55	0.31
WDC06A3-011	0.17	62.21	0.45	0.88	14.66	0.25	1.67	0.30	7.94	6.09	5.16	0.22
WDC06A3-028	0.10	70.82	0.48	0.25	15.94	0.17	1.57	0.06	2.85	1.83	5.84	0.09
WDC06A3-029	0.09	75.28	0.10	0.18	12.72	0.00	0.47	0.09	0.82	2.63	7.18	0.45
WDC06A3-015	0.32	76.07	0.05	0.13	13.21	0.14	0.74	0.05	0.88	3.70	4.55	0.16
WDCA4-01 ²	0.08	54.40	0.09	0.76	15.53	6.67	11.04	0.11	8.91	1.97	0.45	0.00
WDCA4-06	0.03	64.88	0.08	0.44	13.47	0.00	1.06	0.28	8.10	6.95	4.60	0.11

Table 1. Microprobe data from volcanic glass particles found in the WDC06A samples. Data are normalized to 100%.